

# JVC



CASSETTE RECEIVER

KS-FX901/KS-FX801

ENGLISH

卡座收音組合機

KS-FX901/KS-FX801

中文

วิทยุเครื่องเล่นเทป

KS-FX901/KS-FX801

ไทย



KS-FX901

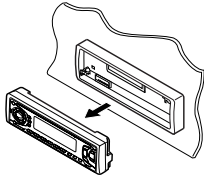
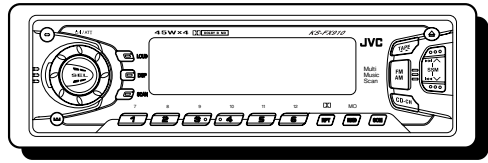

KS-FX801

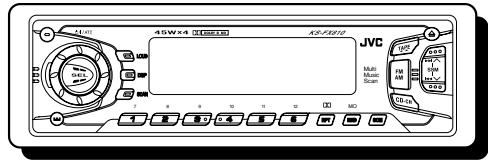

For installation and connections, refer to the separate manual.

有關安裝和連接方法，分別參見操作手冊。





กรุณาดูคู่มือที่แยกต่างหาก ในการติดตั้งและการเชื่อมต่อ

## INSTRUCTIONS

使用說明書  
คำแนะนำ

Thank you for purchasing a JVC product. Please read all instructions carefully before operation, to ensure your complete understanding and to obtain the best possible performance from the unit.

# CONTENTS

How to reset your unit .....	3	
<b>BASIC OPERATIONS .....</b>	<b>4</b>	
<b>RADIO OPERATIONS .....</b>	<b>5</b>	
Listening to the radio .....	5	
Storing stations in memory .....	6	
FM station automatic preset: SSM .....	6	
Manual preset .....	7	
Tuning into a preset station .....	8	
Other convenient tuner functions .....	9	
Scanning broadcast stations .....	9	
Selecting FM reception sound .....	9	
<b>TAPE OPERATIONS .....</b>	<b>10</b>	
Listening to a tape .....	10	
Finding the beginning of a tune .....	12	
Other convenient tape functions .....	13	
Skipping the blank portions on the tape .....	13	
Playing the current tune repeatedly .....	13	
Prohibiting cassette ejection .....	13	
<b>SOUND ADJUSTMENTS .....</b>	<b>14</b>	
Adjusting the sound .....	14	
Turning on/off the loudness function .....	15	
Using the Sound Control Memory .....	16	
Selecting and storing the sound modes .....	16	
Recalling the sound modes .....	17	
Storing your own sound adjustments .....	18	
<b>OTHER MAIN FUNCTIONS .....</b>	<b>19</b>	
Setting the clock .....	19	
Changing the general settings (PSM) .....	20	
Basic Procedure .....	20	
Cancelling Advanced SCM .....	21	
Selecting the level display .....	21	
Selecting the dimmer mode .....	22	
Selecting the external component to use .....	22	
Selecting the telephone muting .....	23	
Detaching the control panel .....	24	

To be continued on the next page

**REMOTE OPERATIONS ..... 25**

- Installing the batteries ..... 25
- Using the remote controller ..... 26



**CD CHANGER OPERATIONS ..... 27**

- Playing CDs ..... 27
- Selecting CD playback modes ..... 29



**EXTERNAL COMPONENT OPERATIONS ..... 30**

- Playing an external component ..... 30



**MAINTENANCE ..... 31**

- To extend the lifetime of the unit ..... 31



**TROUBLESHOOTING ..... 32**

**SPECIFICATIONS ..... 33**

**How to reset your unit**

After detaching the control panel, press reset button on the panel holder using a ball-point pen or similar tool. This will reset the built-in microcomputer.

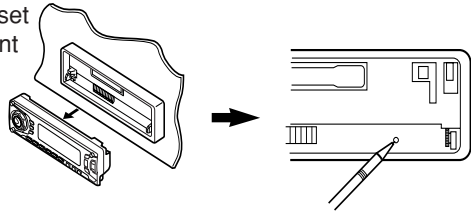

**NOTE:**

*Your preset adjustments — such as preset channels or sound adjustments will also be erased.*

**BEFORE USE**

**\* For safety....**

- Do not raise the volume level too much, as this will block outside sounds, making driving dangerous.
- Stop the car before performing any complicated operations.

**\* Temperature inside the car....**

*If you have parked the car for a long time in hot or cold weather, wait until the temperature in the car becomes normal before operating the unit.*



# BASIC OPERATIONS

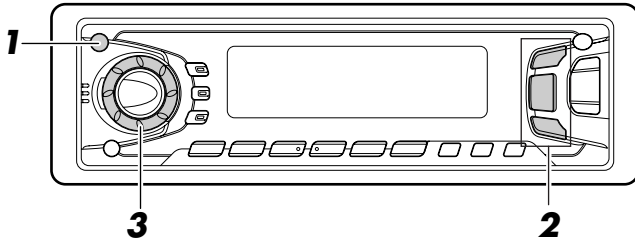

**Note:**

When you use this unit for the first time, set the built-in clock correctly. (See page 19.)

**1**

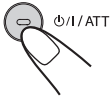

Turn on the power.

"HELLO" appears on the display.

**Note on One-Touch Operation:**

When you select a source in step 2 below, the power automatically comes on. You do not have to press this button to turn on the power.

**2**

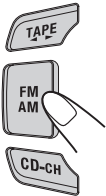

Select the source.

To operate the tuner, see pages 5 – 9.

To operate the cassette deck, see pages 10 – 13.

To operate the CD changer, see pages 27 – 29.

To operate the external component, see page 30.

**3**

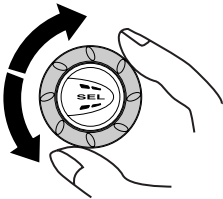

Adjust the volume.

Volume level appears

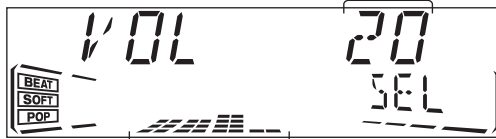

Volume level indicator

**4**

Adjust the sound as you want (see pages 14 – 18).

**To drop the volume in a moment**

Press  $\Phi$ /I/ATT briefly while listening to any source. "ATT" starts flashing on the display, and the volume level will drop in a moment.

To resume the previous volume level, press the button briefly again.

**To turn off the power**

Press  $\Phi$ /I/ATT for more than 1 second.

## Listening to the radio

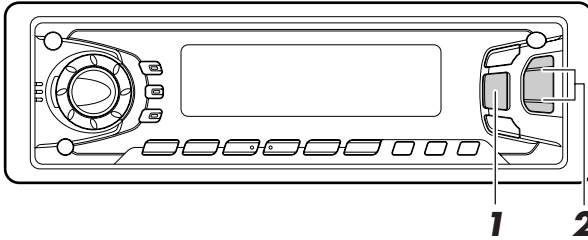

1



Select the band (FM1, FM2, FM3 or AM).

You can select any one of FM1, FM2, and FM3 to listen to an FM station.

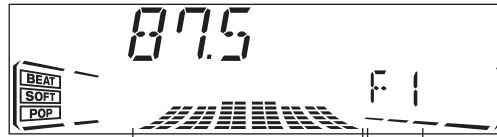
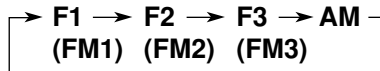

Audio (see page 21) or volume level indicator

Selected band (or clock time: see page 19) appears

2

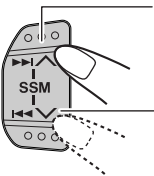

To search stations of higher frequencies.

To search stations of lower frequencies.

Start searching a station.

While searching stations, "SEEK" appears on the display.

When a station is received, searching stops.



To stop searching before a station is received, press the same button you have pressed for searching.

### To tune in a particular frequency without searching:

1 Press FM/AM repeatedly to select the band (FM or AM).

2 Press and hold  $\blacktriangleright\blacktriangleleft$  or  $\blacktriangleleft\blacktriangleright$  until "MANU" (Manual) starts flashing on the display.

Now you can manually change the frequency while "MANU" is flashing.

3 Press  $\blacktriangleright\blacktriangleleft$  or  $\blacktriangleleft\blacktriangleright$  repeatedly until the frequency you want is reached.

- If you hold down the button, the frequency keeps changing (in 50 kHz intervals for FM and in 9 kHz intervals for AM) until you release the button.

# Storing stations in memory

You can use one of the following two methods to store broadcasting stations in memory.

- Automatic preset of FM stations: SSM (Strong-station Sequential Memory)
- Manual preset of both FM and AM stations

## FM station automatic preset: SSM

You can preset 6 local FM stations in each FM band (FM1, FM2 and FM3).

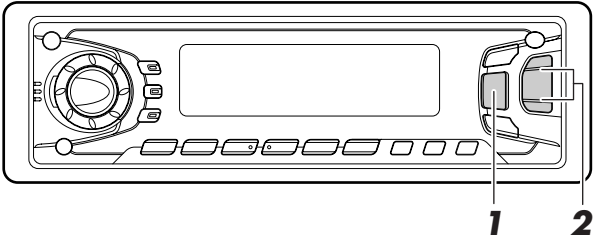

1



Select the FM band number (FM1, FM2 or FM3) you want to store FM stations into.



2

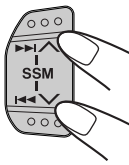

Press and hold both buttons for more than 2 seconds.

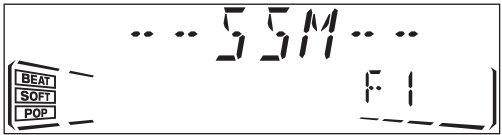

"SSM" appears, then disappears when automatic preset is over.

Local FM stations with the strongest signals are searched and stored automatically in the band number you have selected (FM1, FM2 or FM3). These stations are preset in the number buttons — No. 1 (lowest frequency) to No. 6 (highest frequency).

When automatic preset is over, the station stored in number button 1 will be automatically tuned in.

## Manual preset

You can preset up to 6 stations in each band (FM1, FM2, FM3 and AM) manually.

EXAMPLE: Storing an FM station of 88.3 MHz into the preset channel number 1 of the FM1 band

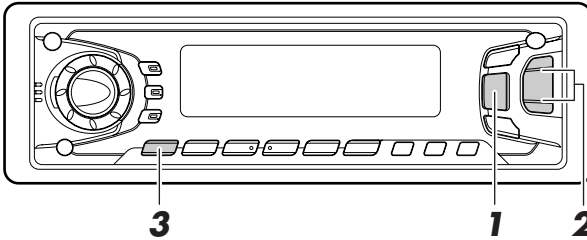
**1**

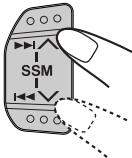

Select the FM1 band.

**2**

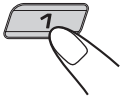
Tune into a station of 88.3 MHz.  
See page 5 to tune into a station.

**3**

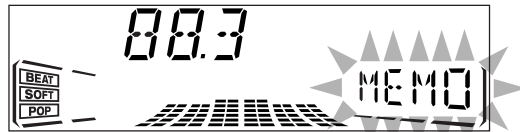
Press and hold the number button (in this example, 1) for more than 2 seconds.



Selected band, preset number and “MEMO” flash alternately for a while.

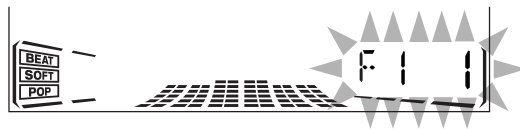

**4** Repeat the above procedure to store other stations into other preset channel numbers.

### Notes:

- A previously preset station is erased when a new station is stored in the same preset channel number.
- Preset stations are erased when the power supply to the memory circuit is interrupted (for example, during battery replacement). If this occurs, preset the stations again.

# Tuning into a preset station

You can easily tune into a preset station.

Remember that you must store stations first. If you have not stored them yet, see pages 6 and 7.

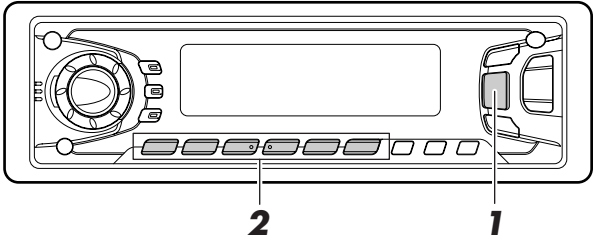

**1**



Select the band (FM1, FM2, FM3 or AM) you want.



**2**



Select the number (1 – 6) for the preset station you want.



## Other convenient tuner functions

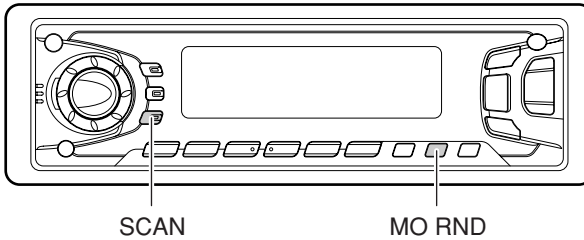

### Scanning broadcast stations

When you press SCAN while listening to the radio, station scanning starts. Each time a broadcast is tuned in, scanning stops for about 5 seconds (tuned frequency flashes on the display), and you can check what program is now being broadcasted.

If you want to listen to that program, press the same button again to stop scanning.

### Selecting FM reception sound

**When an FM stereo broadcast is hard to receive:**

Press MO RND (Monaural/Random) while listening to an FM stereo broadcast. The MONO indicator lights up on the display. The sound you hear becomes monaural but reception will be improved.

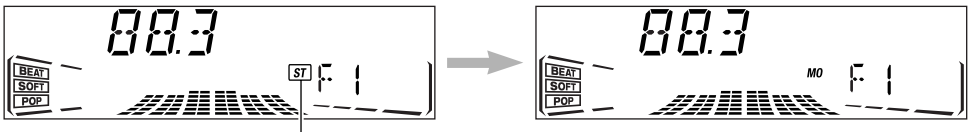

Lights up when receiving an FM broadcast in stereo.

**To restore the stereo effect, press the same button again.**



# TAPE OPERATIONS

## Listening to a tape

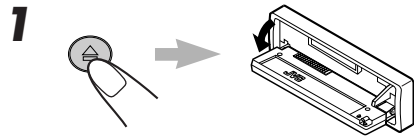
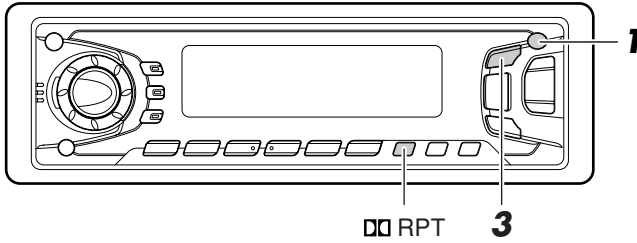

Open the control panel.

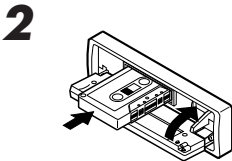

1. Insert a cassette into the cassette compartment.  
The unit turns on and tape play starts automatically.
2. Close the control panel by hand.

- When one side of the tape reaches its end during play, the other side of the tape automatically starts playing. (Auto Reverse)

**Note on One-Touch Operation:**  
When a cassette is already in the cassette compartment, pressing **TAPE** ◀▶ turns on the unit and starts tape play automatically.



Select the tape direction.  
Each time you press the button, the tape direction changes alternately – forward (*FW* PLAY) and reverse (*REV* PLAY).

**To play back tapes recorded with the Dolby B NR**  
Press **DD RPT** (Dolby NR/Repeat) for more than 2 seconds to set the Dolby B NR\* system. The **DD** indicator lights up, and “DOLBY B” appears on the display for several seconds.  
**To cancel the Dolby B NR**, press the same button again.

\* Dolby noise reduction manufactured under license from Dolby Laboratories Licensing Corporation.  
“DOLBY” and the double-D symbol **DD** are trademarks of Dolby Laboratories Licensing Corporation.



## To stop play and eject the cassette

Press ▲.

Tape play stops, the control panel opens, then the cassette automatically ejects from the cassette compartment.

If you change the source to FM, AM or CD changer, the tape play also stops (without ejecting the cassette this time).

• *You can also eject the cassette with the unit turned off.*

## To fast-forward and rewind a tape

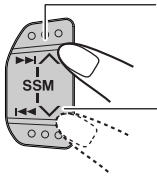

Press ►►|▲ for more than 1 second to fast-forward the tape.

When the tape reaches its end, the tape is reversed and playback starts from the beginning of the other side.

Press |◀◀▼ for more than 1 second to rewind the tape.

When the tape reaches its end, playback of the same side starts.

**To stop fast forward and rewind at any position on the tape, press TAPE ◀▶.**

Tape play starts from that position on the tape.



## Finding the beginning of a tune

Multi Music Scan allows you to automatically start playback from the beginning of a specified tune. You can specify up to 9 tunes ahead of or before the current tune.

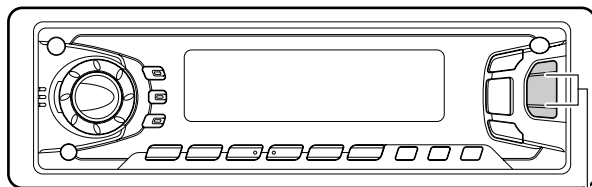

### During playback

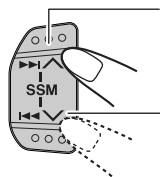

To locate a tune ahead of the current tune on the tape

To locate a tune before the current tune on the tape

Specify where (how many tunes ahead of or before the current tune) the tune you want is located.

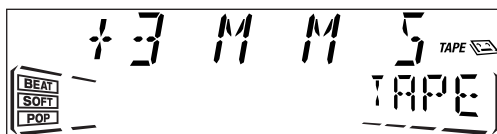

Each time you set the tune, the number changes up to  $\pm 9$ .

When the beginning of the specified tune is located, playback starts automatically.

### Notes:

- While locating a specified tune:
  - If the tape is rewound to its beginning, playback starts from the beginning of that side.
  - If the tape is fast-forwarded to the end, it is reversed and played from the beginning of the other side.
- In the following cases, the Multi Music Scan function may not operate correctly:
  - Tapes with tunes having long pianissimo passages (very quiet parts) or non-recorded portions between tunes.
  - Tapes with short non-recorded sections.
  - Tapes with high level of noise or humming between tunes.
  - The Dolby NR setting does not match. For example, if Dolby B NR is on and the tape was recorded with no Dolby NR.



## Other convenient tape functions

### ***Skipping the blank portions on the tape***

You can skip blank portions between the tunes. (Blank Skip)

When this function is on, the unit skips blank portions of 15 seconds or more, fast-forwards to the next tunes, then starts playing it.

• See also “Changing the general settings (PSM)” on page 20.

1. Press and hold SEL (Select) for more than 2 seconds so that one of the PSM items appears on the display.
2. Select “B SKIP (Blank Skip)” with  $\blacktriangleright\blacktriangleright\blacktriangleup$  or  $\blacktriangleleft\blacktriangleleft\blacktriangleright$ .
3. Select the desired mode with the control dial.  
The Blank Skip mode alternates between on and off.

ON  $\leftrightarrow$  OFF

#### **Note:**

When the tape reaches its end while fast-forwarding, the tape direction will be changed automatically.

### ***Playing the current tune repeatedly***

You can play the current tune repeatedly. (Repeat Play)

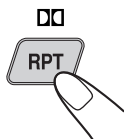

Each time you briefly press  $\square\square$  RPT (Dolby NR/Repeat) while playing a tape, Repeat Play turns on and off alternately.

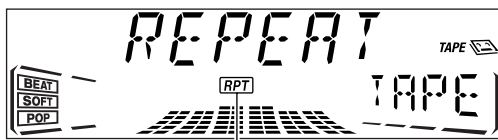

Lights up when Repeat Play is turned on.

#### **Notes:**

- In the following cases, Blank Skip and Repeat Play may not operate correctly:
  - Tapes with tunes having long pianissimo passages (very quiet parts) or non-recorded portions during tunes.
  - Tapes with short non-recorded sections.
  - Tapes with high level noise or humming between tunes.
  - The Dolby NR setting does not match. For example, if Dolby B NR is on and the tape was recorded with no Dolby NR.

### ***Prohibiting cassette ejection***

You can prohibit the cassette ejection and can “lock” a cassette in the cassette compartment. Press and hold  $\blacktriangleleft$  TAPE and  $\text{O}/\text{I}/\text{ATT}$  for more than 2 seconds. “NO EJECT” flashes on the display for about 5 seconds, and the cassette is “locked.”

To cancel the prohibition and “unlock” the cassette, press and hold TAPE  $\blacktriangleleft$   $\blacktriangleright$  and  $\text{O}/\text{I}/\text{ATT}$  for more than 2 seconds again. “EJECT OK” flashes for about 5 seconds, and this time the cassette is “unlocked.”



# SOUND ADJUSTMENTS

ENGLISH

## Adjusting the sound

You can adjust the treble/bass sound and the speaker balance.

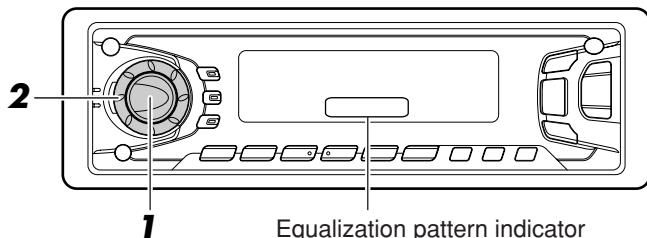

1



Select the item you want to adjust.

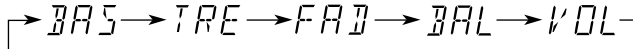

Indication	To do:	Range
BAS (Bass)	Adjust the bass	-06 (min.) — +06 (max.)
TRE (Treble)	Adjust the treble	-06 (min.) — +06 (max.)
FAD (Fader)*	Adjust the front and rear speaker balance	R06 (rear only) — F06 (front only)
BAL (Balance)	Adjust the left and right speaker balance	L06 (left only) — R06 (right only)
VOL (Volume)	Adjust the volume	00 (min.) — 50 (max.)

**Note:**

\* If you are using a two-speaker system, set the fader level to "00."

2

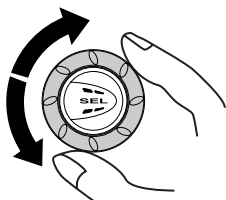

Adjust the level.



Equalization pattern changes as you adjust the bass or treble.

**Note:**

Normally the control dial works for volume adjustment. So you do not have to select "VOL" to adjust the volume level.



## Turning on/off the loudness function

The human ear is less sensitive to low and high frequencies at low volumes. The loudness function can boost these frequencies to produce well-balanced sound at low volume level.

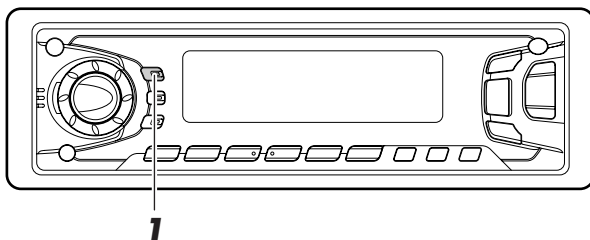

1

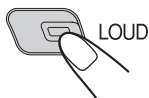

Turn on or off the loudness function.

Each time you press LOUD, the loudness function turns on and off alternately.





# Using the Sound Control Memory

You can select and store a preset sound adjustment suitable to each playback source. (Advanced SCM)

## Selecting and storing the sound modes

Once you select a sound mode, it is stored in memory, and will be recalled every time you select the same source. A sound mode can be stored each of the following sources — FM1, FM2, FM3, AM, tape, CD-Changer and external components.

- If you do not want to store the sound mode separately for each playback source, but want to use the same sound mode for all the sources, see “Canceling Advanced SCM” on page 21.

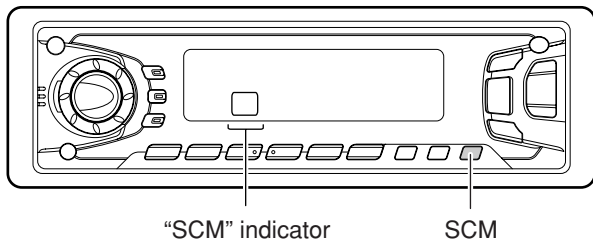

### Select the sound mode you want.

Each time you press the button, the sound mode changes as follows:

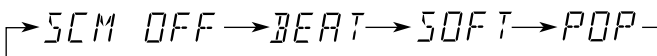

- When “SCM LINK” is set to “LINK ON”, the selected sound mode can be stored in memory for the current source and the effect applies only to the current source. Each time you change the playback source, the SCM indicator flashes on the display.
- When “SCM LINK” is set to “LINK OFF”, the selected sound mode effect applies to any source.

Indication	For:	Preset values		
		Bass	Treble	Loudness
SCM OFF	(Flat sound)	00	00	On
BEAT	Rock or disco music	+02	00	On
SOFT	Quiet background music	+01	-03	Off
POP	Light music	+04	+01	Off



## Recalling the sound modes

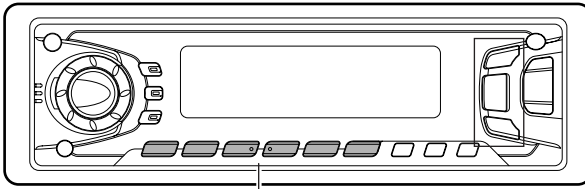

Source buttons

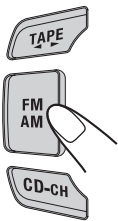

Select the source while the “SCM” indicator is lit on the display.

The “SCM” indicator starts flashing, and the sound mode stored in memory for the selected source is recalled.

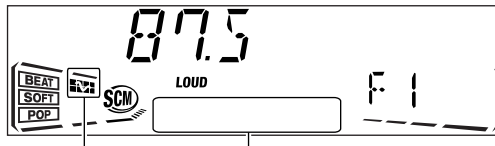

Sound mode indicator

Equalization pattern of the selected sound mode appears.

### Notes:

- You can adjust each sound mode to your preference, and store it in memory. If you want to adjust and store your original sound mode, see “Storing your own sound adjustments” on page 18.
- To adjust the bass and treble reinforcement levels or to turn on/off the loudness function temporarily, see pages 14 and 15. (Your adjustments will be canceled if another source is selected.)



## Storing your own sound adjustments

You can adjust the sound modes (BEAT, SOFT, POP: see page 16) to your preference and store your own adjustments in memory.

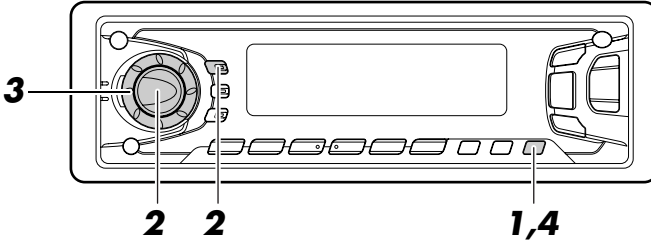

**1**



Call up the sound mode you want to adjust.  
See page 16 for details.

*Within  
5 seconds*

**2**



To adjust the bass or treble sound level  
Select "BAS" or "TRE."

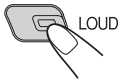

To turn on or off the loudness function  
See page 15 for details.

*Within  
5 seconds*

**3**



Adjust the bass or treble level.  
See page 14 for details.

*Within  
5 seconds*

**4**



Press and hold SCM (Sound Control Memory)  
until the sound mode you have selected  
flashes on the display.  
Your setting is stored in memory.

**5**

Repeat the same procedure to store other settings.

### To reset to the factory settings

Repeat the same procedure and reassign the preset values listed in the table on page 16.

## Setting the clock

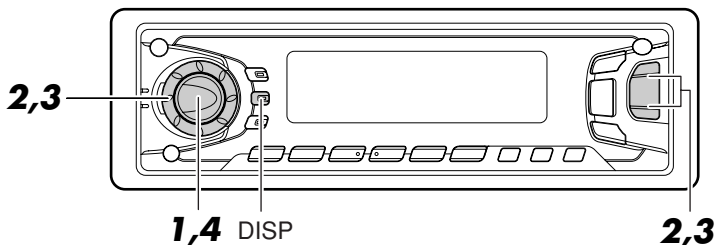

**1** Press and hold SEL (Select) for more than 2 seconds so that one of the PSM items appears on the display.

**2** Set the hour.

- 1 Select "CLOCK H (Hour)" if not shown on the display.
- 2 Adjust the hour.

**3** Set the minute.

- 1 Select "CLOCK M (Minute)".
- 2 Adjust the minute.

**4** Finish the setting.

### To check the current clock time (changing the display mode)

Press DISP repeatedly. Each time you press the button, the display mode changes as follows:

<p><b>During tuner operation:</b></p> <p>Band ↔ Clock</p>	<p><b>During tape operation:</b></p> <p>TAPE ↔ Clock</p>
<p><b>During CD Changer operation:</b></p> <p>Disc number ↔ Clock</p>	<p><b>During external component operation:</b></p> <p>Clock appears and disappears alternately.</p>

- If the unit is not in use when you press DISP, the power turns on, the clock time is shown for 5 seconds, then the power turns off.

## Changing the general settings (PSM)

You can change the items listed on the next page by using the PSM (Preferred Setting Mode) control.

### Basic Procedure

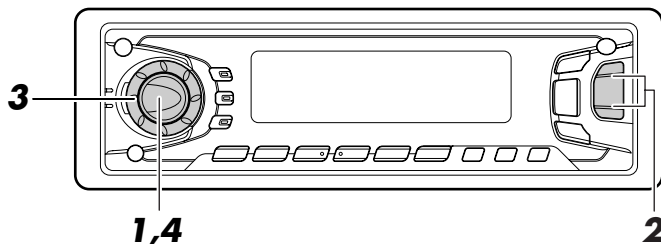

**1**



Press and hold SEL (Select) for more than 2 seconds so that one of the PSM items appears on the display.

**2**

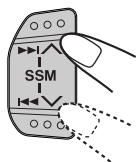

Select the PSM item you want to adjust. (See page 21.)

**3**

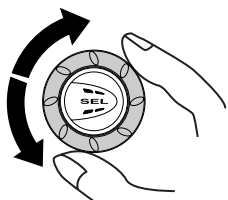

Select or adjust the PSM item selected above.

**4**

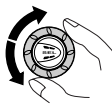

Finish the setting.

<b>1</b>	<b>2</b>	<b>3</b>		Factory-preset settings	See page
	Select.		Set.		
<b>CLOCK H</b>	Hour adjustment	Back	Advance	0:00	19
<b>CLOCK M</b>	Minute adjustment	Back	Advance		
<b>SCM LINK</b>	Sound control memory linkage	LINK OFF	LINK ON	LINK ON	below
<b>LEVEL</b>	Level display	AUDIO 1 ↔ AUDIO 2 ↕ OFF ↕		AUDIO 2	below
<b>DIMMER</b>	Dimmer	AUTO ↔ OFF ↕ ON ↕		AUTO	22
<b>TEL</b>	Auto mute for cellular phone system	OFF ↔ MUTING 1 ↕ MUTING 2 ↕		OFF	23
<b>B. SKIP</b>	Blank skip	OFF	ON	OFF	13
<b>LINE IN*</b>	External component	CHANGER	LINE IN	CHANGER	22

\* Displayed only when one of the following sources is selected — FM, AM and tape.

- Press SEL (select) when the setting is complete.

## Canceling Advanced SCM

You can cancel the Advanced SCM (Sound Control Memory), and unlink the sound modes and the playback sources.

When shipped from the factory, a different sound mode can be stored in memory for each source so that you can change the sound modes simply by changing the sources.

- LINK ON: Advanced SCM (different sound modes for different sources)
- LINK OFF: Conventional SCM (one sound mode for all sources)

1. Press and hold SEL (Select) for more than 2 seconds so that one of the PSM items appears on the display.
2. Select "SCM LINK" with **▶▶▶▲** or **◀◀◀▼**.
3. Select the desired mode with the control dial.

The SCM LINK mode changes as follows:

**LINK ON** ← → **LINK OFF**

## Selecting the level display

You can select the level display according to your preference.

When shipped from the factory, "AUDIO 2" is selected.

- AUDIO 1: Shows the audio level indicator and the equalization pattern indicator.
- AUDIO 2: Alternates "AUDIO 1" setting and illumination display.
- OFF: Erases the audio level indicator and the equalization pattern indicator.

1. Press and hold SEL (Select) for more than 2 seconds so that one of the PSM items appears on the display.
2. Select "LEVEL" with **▶▶▶▲** or **◀◀◀▼**.
3. Select the desired mode with the control dial.

The level display setting changes as follows:

→ **AUDIO 1** ← → **AUDIO 2** ← → **OFF** ←

## Selecting the dimmer mode

When you turn on the car head lights, the display automatically dims (Auto Dimmer). When shipped from the factory, Auto Dimmer mode is activated.

- AUTO: Activates Auto Dimmer.
- ON: Always dims the display.
- OFF: Cancels Auto Dimmer.

1. Press and hold SEL (Select) for more than 2 seconds so that one of the PSM items appears on the display.
2. Select "DIMMER" with ►►|▲ or |◄◄▼.
3. Select the desired mode with the control dial.  
The dimmer mode changes as follows:



### Note on Auto Dimmer:

*Auto Dimmer equipped with this unit may not work correctly on some vehicles, particularly on those having a control dial for dimming.*

*In this case, set the dimmer mode to "ON" or "OFF".*

## Selecting the external component to use

You can connect the external component to the CD changer jack on the rear using the Line Input Adaptor KS-U57 (not supplied).

To use the external component as the playback source through this unit, you need to select which component — CD changer or external component — to use. When shipped from the factory, CD changer is selected as the external component.

- LINE IN: To use the external component other than CD changer.
- CHANGER: To use the CD changer.

1. Change the source to FM, AM or tape with FM/AM or TAPE ◀️►.
2. Press and hold SEL (Select) for more than 2 seconds so that one of the PSM items appears on the display.
3. Select "LINE IN" with ►►|▲ or |◄◄▼.
4. Select the desired mode with the control dial.  
The external component selecting mode changes as follows:

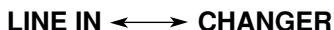

### Note:

*For connecting the Line Input Adaptor KS-U57 and the external component, refer to the Installation/Connection Manual (separate volume).*

## Selecting the telephone muting

This mode is used when a cellular phone system is connected. Depending on the phone system used, select either "MUTING 1" or "MUTING 2," whichever mutes the sounds from this unit. When shipped from the factory, this mode is deactivated.

- MUTING 1: Select this if this setting can mute the sounds.
- MUTING 2: Select this if this setting can mute the sounds.
- OFF: Cancels the telephone muting.

1 Press and hold SEL (select) for more than 2 seconds so that one of the PSM items appears on the display.

2 Select "TEL (Telephone)" with ►►| ^ or ◀◀| v.

3 Select the desired mode with the control dial.

The telephone muting mode changes as follows:



## Detaching the control panel

You can detach the control panel when leaving the car. When detaching or attaching the control panel, be careful not to damage the connectors on the back of the control panel and on the panel holder.

### How to detach the control panel

Before detaching the control panel, be sure to turn off the power.

- 1 Unlock the control panel.

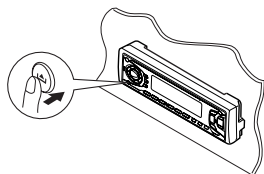

- 2 Pull the control panel out of the unit.

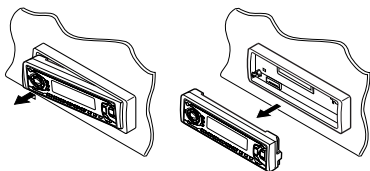

- 3 Put the detached control panel into the provided case.

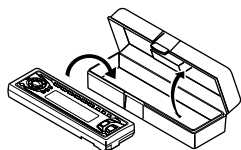

### How to attach the control panel

- 1 Insert the right side of the control panel into the groove on the panel holder.

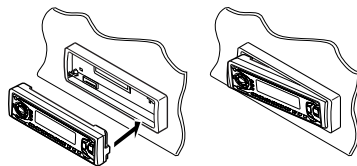

- 2 Press the left side of the control panel to fix it to the panel holder.

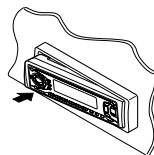

#### Note on cleaning the connectors:

*If you frequently detach the control panel, the connectors will deteriorate.*

*To minimize this possibility, periodically wipe the connectors with a cotton swab or cloth moistened with alcohol, being careful not to damage the connectors.*

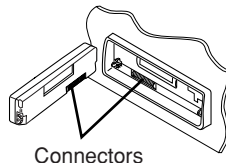





Before using the remote controller:

- Aim the remote controller directly at the remote sensor on the main unit. Make sure there is no obstacle in between.
- Do not expose the remote sensor to strong light (direct sunlight or artificial lighting).

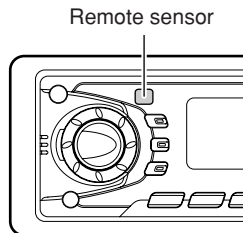

## Installing the battery

When the controllable range or effectiveness of the remote controller decreases, replace the battery.

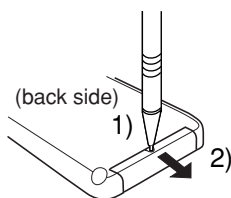

### 1. Remove the battery holder.

- 1) Push out in the direction indicated by the arrow using a ball point pen or a similar tool.
- 2) Remove the battery holder.

Lithium coin battery  
(product number:  
CR2025)

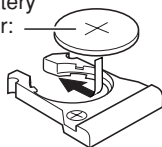

### 2. Place the battery.

Slide the battery into the holder with the + side facing upwards so that the battery is fixed in the holder.

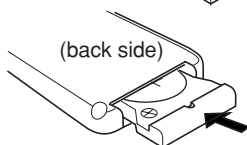

### 3. Return the battery holder.

Insert again the battery holder pushing it until you hear a clicking sound.

### WARNING:

- Store the batteries in a place which children cannot reach.  
*If a child accidentally swallows the battery, immediately consult a doctor.*
- Do not recharge, short, disassemble or heat the batteries or dispose of in a fire.  
*Doing any of these things may cause the batteries to give off heat, crack or start a fire.*
- Do not leave the batteries with other metallic materials.  
*Doing this may cause the batteries to give off heat, crack or start a fire.*
- When throwing away or saving the batteries, wrap in tape and insulate; otherwise, it may cause the batteries to give off heat, crack or start a fire.
- Do not poke the batteries with tweezers or similar tools.  
*Doing this may cause the batteries to give off heat, crack or start a fire.*

## Using the remote controller

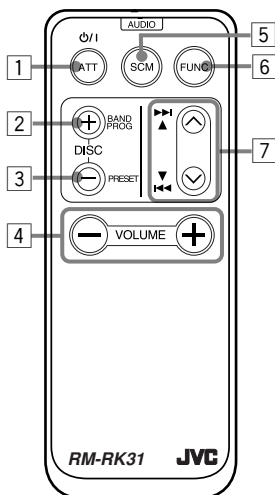

- 1 Functions the same as the  $\Phi$ /I/ATT button on the main unit.
- 2
  - Functions as the BAND button while listening to the radio. Each time you press the button, the band changes.
  - Functions as the DISC + button while listening to the CD changer. Each time you press the button, the disc number increases, and the selected disc starts playing.
  - Functions as the PROG button while listening to a tape. Each time you press the button, the tape direction changes alternately.
- 3
  - Functions as the PRESET button while listening to the radio. Each time you press the button, the preset station number increases, and the selected station is tuned in.
  - Functions as the DISC – button while listening to the CD changer. Each time you press the button, the disc number decreases, and the selected disc starts playing.
- 4 Functions the same as the control dial on the main unit.
 

**Note:** This button does not function for the preferred settings mode adjustment.
- 5 Selects the sound mode. Each time you press SCM (Sound Control Memory), the mode changes.
- 6 Selects the source. Each time you press FUNC (Function), the source changes.
- 7
  - Searches stations while listening to the radio.
  - Functions as the fast forward or rewind buttons or Multi Music Scan buttons while listening to a tape.
  - Fast-forwards or reverses the track if pressed and held while listening to the CD.
  - Skips to the beginning of the next tracks or go back to the beginning of the current (or previous tracks) if pressed briefly while listening to the CD.

# CD CHANGER OPERATIONS



We recommend that you use one of the CH-X series with your unit.

If you have another CD changer, consult your JVC car audio dealer for connections.

- For example, if your CD changer is one of the KD-MK series, you need a cord (KS-U15K) for connecting it to this unit.

Before operating your CD changer:

- Refer also to the Instructions supplied with your CD changer.
- If no discs are in the magazine of the CD changer or the discs are inserted upside down, "NO DISC" will appear on the display. If this happens, remove the magazine and set the discs correctly.
- If "RESET 1 - RESET 8" appears on the display, something is wrong with the connection between this unit and the CD changer. If this happens, check the connection, connect the connecting cord(s) firmly if necessary, then press the reset button of the CD changer.

## Playing CDs

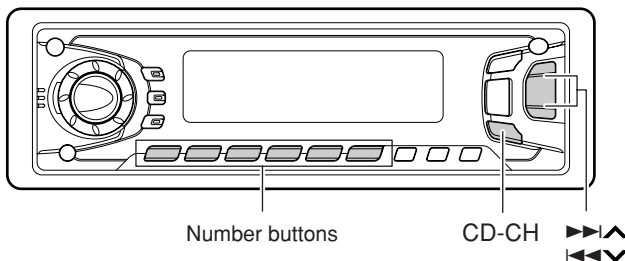

### Select the CD changer.

Playback starts from the first track of the first disc.  
All tracks of all discs are played back.



Disc number (or clock time: see page 19) appears.

### Note on One-Touch Operation:

When you press CD-CH, the power automatically comes on. You do not have to press /WATT to turn on the power.



## To fast-forward or reverse the track

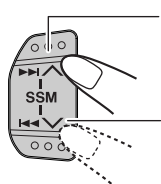

Press and hold **▶▶|▲**, while playing a CD, to fast-forward the track.

Press and hold **◀◀|▼**, while playing a CD, to reverse the track.

## To go to the next tracks or the previous tracks

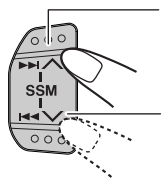

Press **▶▶|▲** briefly, while playing a CD, to go ahead to the beginning of the next track.

Each time you press the button consecutively, the beginning of the next tracks is located and played back.

Press **◀◀|▼** briefly, while playing a CD, to go back to the beginning of the current track.

Each time you press the button consecutively, the beginning of the previous tracks is located and played back.

## To go to a particular disc directly

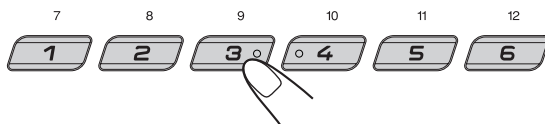

Press the number button corresponding to the disc number to start its playback (while the CD changer is playing).

- To select a disc number from 1 – 6:  
Press 1 (7) – 6 (12) briefly.
- To select a disc number from 7 – 12:  
Press and hold 1 (7) – 6 (12) for more than 1 second.

Ex. When disc number 3 is selected

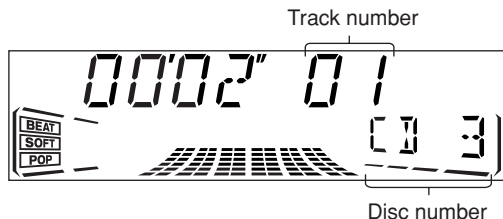



# Selecting CD playback modes

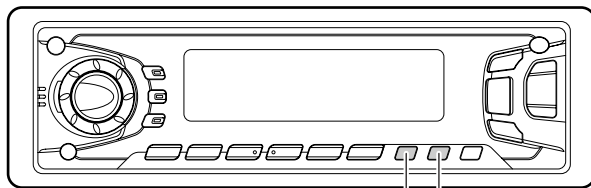

□□ RPT MO RND

## To play back tracks at random (Random Play)

Each time you press MO RND (Monaural/Random) while playing a CD, CD random play mode changes as follows:

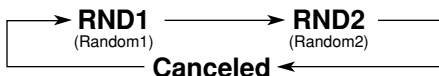
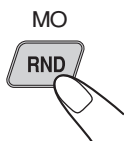

Mode	RND Indicator	Plays at random
RND1	Lights	All tracks of the current disc, then the tracks of the next disc, and so on.
RND2	Flashes	All tracks of all discs inserted in the magazine.

## To play back tracks repeatedly (Dolby NR/Repeat Play)

Each time you press □□ RPT (Dolby NR/Repeat) while playing a CD, CD repeat play mode changes as follows:

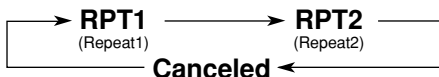
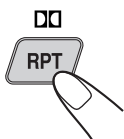

Mode	RPT Indicator	Plays repeatedly
RPT1	Lights	The current track (or specified track).
RPT2	Flashes	All tracks of the current disc (or specified disc).



# EXTERNAL COMPONENT OPERATIONS

## Playing an external component

You can connect the external component to the CD changer jack on the rear using the Line Input Adaptor KS-U57 (not supplied).

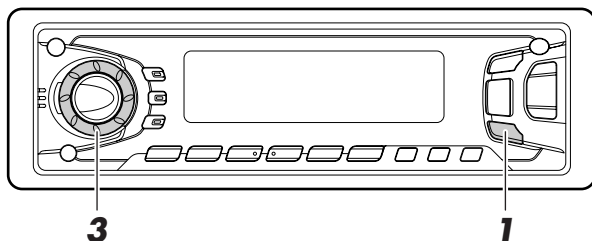

### Preparations:

- For connecting the Line Input Adaptor KS-U57 and the external component, refer to the Installation/Connection Manual (separate volume).
- Before operating the external component using the following procedure, select the external input correctly. (See “Selecting the external component to use” on page 22.)

1



Select the external component.



- If “LINE IN”<sup>\*</sup> does not appear on the display, see page 21 and select the external input (“EXT IN”).

<sup>\*</sup>Displayed only when one of the following sources is selected — FM, AM and tape.

### Note on One-Touch Operation:

When you press CD-CH, the power automatically comes on. You do not have to press /I/ATT to turn on the power.

2

Turn on the connected component and start playing the source.

3

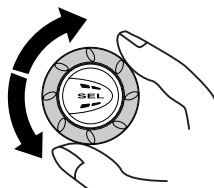

Adjust the volume.

## To extend the lifetime of the unit

This unit requires very little attention, but you will be able to extend the life of the unit if you follow the instructions below.

### To clean the heads

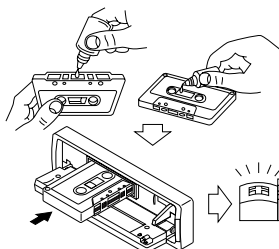

- Clean the heads after every 10 hours of use using a wet-type head cleaning tape (available at an audio store). When the head becomes dirty, you may realize the following symptoms:
  - Sound quality is reduced.
  - Sound level decreases.
  - Sound drops out.
- Do not play dirty or dusty tapes.
- Do not touch the highly-polished head with any metallic or magnetic tools.

### To keep the tape clean

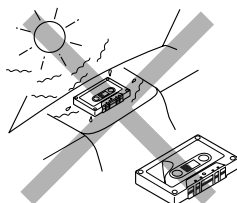

- Always store the tapes to their storage cases after use.
- Do not store tapes in the following places:
  - Subject to direct sunlight
  - With high humidity
  - At extremely hot temperatures

### CAUTIONS:

- Do not play the tapes with peeling labels; otherwise, they can damage the unit.
- Tighten tapes to remove slack since loose tape may become entangled with the mechanism.
- Do not leave a cassette in the cassette compartment after use, as the tape may become slack.

The function below is also provided to ensure the longer life of this unit.

### Ignition key-off Release/Ignition key-on play

- When you turn off the ignition key with a cassette in the compartment, the unit automatically releases the tape from its head.
- When you turn on the ignition key with a cassette in the compartment, playback automatically starts.



# TROUBLESHOOTING

What appears to be trouble is not always serious. Check the following points before calling a service center.

Symptoms	Causes	Remedies
• A cassette tape cannot be inserted.	You have tried to insert a cassette in the wrong way.	Insert the cassette with the exposed tape facing right.
• Cassette tapes become hot.	This is not a malfunction.	_____
• Tape sound is at very low level and sound quality is degraded.	The tape head is dirty.	Clean it with a head cleaning tape.
• Sound is sometimes interrupted.	Connections are not good.	Check the cords and connections.
• Sound cannot be heard from the speakers.	The volume is turned to the minimum level.	Adjust it to the optimum level.
	Connections are incorrect.	Check the cords and connections.
• SSM (Strong-station Sequential Memory) automatic preset does not work.	Signals are too weak.	Store stations manually.
• Static noise while listening to the radio.	The antenna is not connected firmly.	Connect the antenna firmly.
• "NO DISC" appears on the display.	No CD is in the magazine.	Insert CDs into the magazine.
	CDs are inserted incorrectly.	Insert them correctly.
• "RESET 8" appears on the display.	This unit is not connected to a CD changer correctly.	Connect this unit and the CD changer correctly and press the reset button of the CD changer.
• "RESET 1 - RESET 7" appears on the display.	_____	Press the reset button of the CD changer.
• This unit does not work at all. • The CD changer does not work at all.	The built-in microcomputer may function incorrectly due to noise, etc.	Press the reset button on the panel (The clock setting and preset stations stored in memory are erased.) (See page 3.)



# SPECIFICATIONS ?!

## AUDIO AMPLIFIER SECTION

Maximum Power Output:

Front: 45 W per channel

Rear: 45 W per channel

Continuous Power Output (RMS):

Front: 17 W per channel into 4  $\Omega$ , 40Hz to 20 000 Hz at no more than 0.8% total harmonic distortion.

Rear: 17 W per channel into 4  $\Omega$ , 40Hz to 20 000 Hz at no more than 0.8% total harmonic distortion.

Load Impedance: 4  $\Omega$  (4  $\Omega$  to 8  $\Omega$  allowance)

Tone Control Range

Bass:  $\pm 10$  dB at 100 Hz

Treble:  $\pm 10$  dB at 10 kHz

Frequency Response: 40 Hz to 20 000 Hz

Signal-to-Noise Ratio: 70 dB

Line-Out Level/Impedance: 2.0 V/20 k $\Omega$  load (250 nWb/m)

## TUNER SECTION

Frequency Range

FM: 87.5 MHz to 108.0 MHz

AM: 531 kHz to 1 602 kHz

### [FM Tuner]

Usable Sensitivity: 11.3 dBf (1.0  $\mu$ V/75  $\Omega$ )

50 dB Quieting Sensitivity:

16.3 dBf (1.8  $\mu$ V/75  $\Omega$ )

Alternate Channel Selectivity (400 kHz):

65 dB

Frequency Response: 40 Hz to 15 000 Hz

Stereo Separation: 35 dB

Capture Ratio: 1.5 dB

### [AM Tuner]

Sensitivity: 20  $\mu$ V

Selectivity: 35 dB

## CASSETTE DECK SECTION

Wow & Flutter: 0.11% (WRMS)

Fast-Wind Time: 100 sec. (C-60)

Frequency Response (Dolby NR-OFF):

30 Hz to 16 000 Hz (Normal tape)

Signal-to-Noise Ratio: (Normal tape)

(Dolby NR-ON): 65 dB

(Dolby NR-OFF): 56 dB

Stereo Separation: 40 dB

## GENERAL

Power Requirement

Operating Voltage: DC 14.4 V (11 V to 16 V allowance)

Allowable Working Temperature:

0°C to +40°C (32°F to 104°F)

Grounding System: Negative ground

Dimensions (W x H x D)

Installation Size:

182 mm x 52 mm x 150 mm

Panel Size: 188 mm x 58 mm x 14 mm

Mass: 1.4 kg (2.9 lbs) (excluding accessories)

*Design and specifications subject to change without notice.*

If a kit is necessary for your car, consult your telephone directory for the nearest car audio speciality shop.

## Having TROUBLE with operation?

### Please reset your unit

Refer to page of How to reset your unit

## KS-FX901/KS-FX801

## راديو مع مشغل اشربة كاسيت

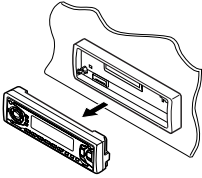

### KS-FX901

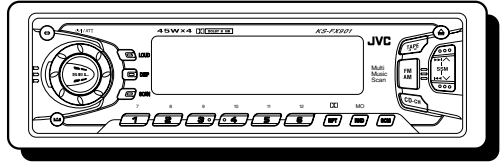

### KS-FX801

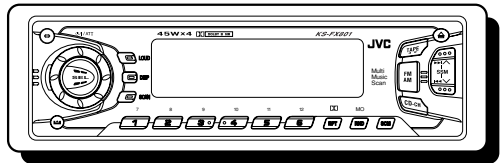

لعمليات التركيب والتوصيلات، يرجى مراجعة كتيب التعليمات المنفصل.

## دليل التعليمات

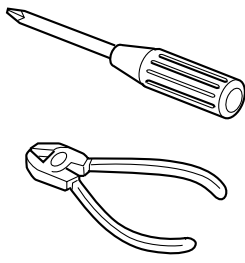

#### ENGLISH

- This unit is designed to operate on 12 volts DC, NEGATIVE ground electrical systems.

## INSTALLATION (IN-DASH MOUNTING)

- The following illustration shows a typical installation. However, you should make adjustments corresponding to your specific car. If you have any questions or require information regarding installation kits, consult your JVC car audio dealer or a company supplying kits.

- Before mounting:** Press (Control Panel Release button) to detach the control panel if already attached.  
\* When shipped from the factory, the control panel is packed in the hard case.
- Remove the trim plate.
- Remove the sleeve after disengaging the sleeve locks.
  - Stand the unit.

**Note:** When you stand the unit, be careful not to damage the fuse on the rear.

  - Insert the 2 handles between the unit and the sleeve, as illustrated, to disengage the sleeve locks.
  - Remove the sleeve.

**Note:** Be sure to keep the handles for future use after installing the unit.
- Install the sleeve into the dashboard.  
\* After the sleeve is correctly installed into the dashboard, bend the appropriate tabs to hold the sleeve firmly in place, as illustrated.
- Fix the mounting bolt to the rear of the unit's body and place the rubber cushion over the end of the bolt.
- Do the required electrical connections explained on the back of this instructions.
- Slide the unit into the sleeve until it is locked.
- Attach the trim plate so that the projection on the trim plate is fixed to the left side of the unit.
- Attach the control panel.

#### 中文

- 本機僅可使用直流 12V、負極接地的電源系統。

## 安裝 (裝設、固定在儀表板內)

- 下面的圖解表示了典型的安裝程序。然而，您應當做些適當的調整，以便適應您自己的汽車。如果您有問題，或需要有關配套元件的資料，請向 JVC 汽車音響分銷商或配套元件供應公司詢問。

- 裝設之前：**如果控制面板已經裝上，按下 (控制面板解脫按鈕)，拆脫控制面板。  
\* 當控制面板從工廠裝運時，它是包裝在硬盒中的。
- 取下裝飾框。
- 解開扣板，取下本機的外套機殼。
  - 將本機豎起。  
**註：**您豎起本機時，小心不要損壞底部的保險絲。
  - 按圖所示，在本機和外套機殼之間插入兩片板條型的把手，解開外套機殼扣板。
  - 取下外套機殼。  
**註：**安裝本機後，務必保存好兩片把手，以備將來使用。
- 將外套機殼裝入儀表板內。  
\* 在外套機殼準確地裝入儀表板之後，按圖所示，彎曲機殼的突舌，把外套機殼牢固在儀表板內。
- 將緊固螺栓旋緊在本機機體上，並將橡膠防震墊套在緊固螺栓的尾部。
- 按本說明書後面所述，進行所需要的電路連接。
- 將本機滑入外套機殼，直到扣板鎖住為止。
- 套上裝飾框，並使框上的凸塊和本機上的凹槽對齊合上。
- 裝上控制面板。

#### عربي

- لقد صمم هذا الجهاز ليعمل بواسطة تيار كهربائي مباشر DC، ١٢ فولت، أنظمة كهربائية تأريض سالب.

## تركيب الجهاز (داخل-تابلو السيارة)

- يبيّن الرسم التوضيحي التالي طريقة التركيب المثالية. مع ذلك، يجب عليك عمل تعديلات تطابق نوع السيارة التي تمتلكها. إذا كان هناك استفسارات أو حاجة لمعلومات بخصوص أدوات التركيب، يرجى استشارة موزع الأجهزة الصوتية للسيارات ماركة JVC أو الشركة الموزعة لهذه الأدوات.

- قبل بدء التركيب:** اضغط الرز (زر تحرير لوحة التحكم) من أجل فصل لوحة التحكم. عند الشحن من المصنع، تم وضع لوحة التحكم داخل الصندوق. انزع لوحة الزينة.
- انزع الهيكل الواقي بعد فصل مثبتات الهيكل الواقي.
  - اوقف الجهاز بشكل عمودي.

**ملاحظة:** عند توقيف الجهاز، تأكد من عدم تضرر أو اتلاف الفيوز الموجود في الجهة الخلفية من الجهاز.

  - ادخل المساكين بين الجهاز والهيكل الواقي، كما هو مبين في الشكل، لفصل مثبتات الهيكل الواقي.
  - انزع الهيكل الواقي.
- ملاحظة:** يرجى المحافظة على المساكات من أجل الاستعمال لاحقاً بعد تركيب الجهاز.
- ركب الهيكل الواقي داخل تابلو السيارة.  
\* بعد تركيب الهيكل الواقي كلياً داخل تابلو السيارة بشكل صحيح، اثني الألسنة بشكل مناسب لتثبيت الهيكل الواقي بشكل محكم في المكان الصحيح، كما هو مبين في الشكل.
- ثبّت مسمار التركيب بالجهة الخلفية من هيكل الجهاز وبعد ذلك ضع الحشوة المطاطية فوق نهاية المسمار.
- اعمل التوصيلات الكهربائية المطلوبة كما هو مشروح خلف هذه التعليمات.
- ادخل الجهاز داخل الهيكل الواقي حتى يثبت بشكل صحيح.
- ركّب لوحة الزينة بحيث يتم تثبيت النتوء الموجود على لوحة الزينة على الجانب الأيسر للجهاز.
- ركّب لوحة التحكم.

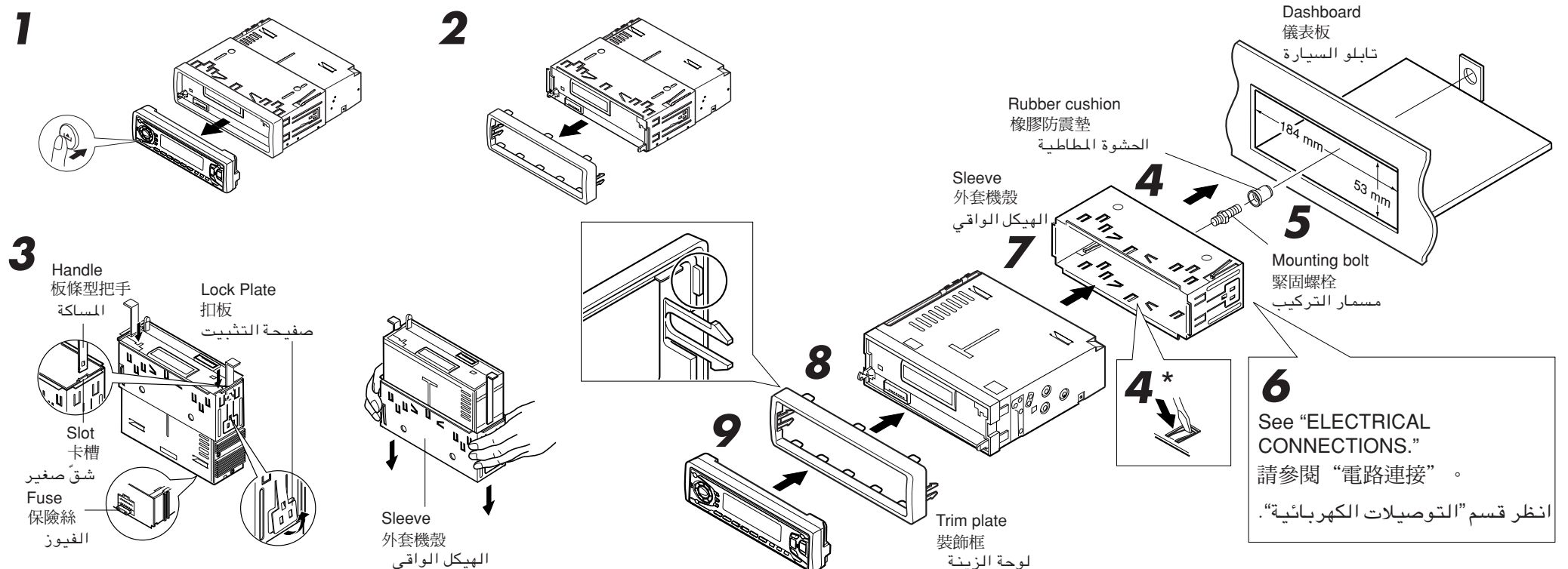

## TROUBLESHOOTING

- The fuse blows.**  
\* Are the red and black leads connected correctly?
- Power cannot be turned on.**  
\* Is the yellow lead connected?
- No sound from the speakers.**  
\* Is the speaker output lead short-circuited?
- Sound is distorted.**  
\* Is the speaker output lead grounded?  
\* Are the “-” terminals of L and R speakers grounded in common?
- Unit becomes hot.**  
\* Is the speaker output lead grounded?  
\* Are the “-” terminals of L and R speakers grounded in common?

## 故障排除

- 保險絲燒斷。  
\* 檢查紅色導線接頭和黑色導線接頭是否連接正確？
- 電源不能接通。  
\* 檢查黃色導線接頭是否接上？
- 揚聲器沒有聲音。  
\* 檢查揚聲器輸出導線接頭是否短路？
- 聲音失真。  
\* 檢查揚聲器輸出端子是否接地？  
\* 檢查揚聲器的左 (L)、右 (R) 端子的負極 (-) 是否共同接地？
- 本機發熱。  
\* 檢查揚聲器輸出端子是否接地？  
\* 檢查揚聲器的左 (L)、右 (R) 端子的負極 (-) 是否共同接地？

## البحث عن الاعطال والاصلاح

- يحترق الفيوز.  
\* هل السلك الاحمر والاسود موصولة بشكل صحيح؟
- لا يمكن توصيل الطاقة الكهربائية.  
\* هل السلك الاصفر موصولاً؟
- لا يصدر صوت من السماعات.  
\* هل هنالك تقصير في دائرة سلك خرج السماعة؟
- الصوت مشوه.  
\* هل سلك خرج السماعة موصولاً بالارض؟  
\* هل الاطراف السالبة «-» للسماعة اليسرى L واليمنى R موصولة بالارض مع بعض؟
- يسخن الجهاز.  
\* هل سلك خرج السماعة موصولاً بالارض؟  
\* هل الاطراف السالبة «-» للسماعة اليسرى L واليمنى R موصولة بالارض مع بعض؟

• When using the optional stay

• 若選用支撐架

• عند استخدام مسند اضافي للتثبيت

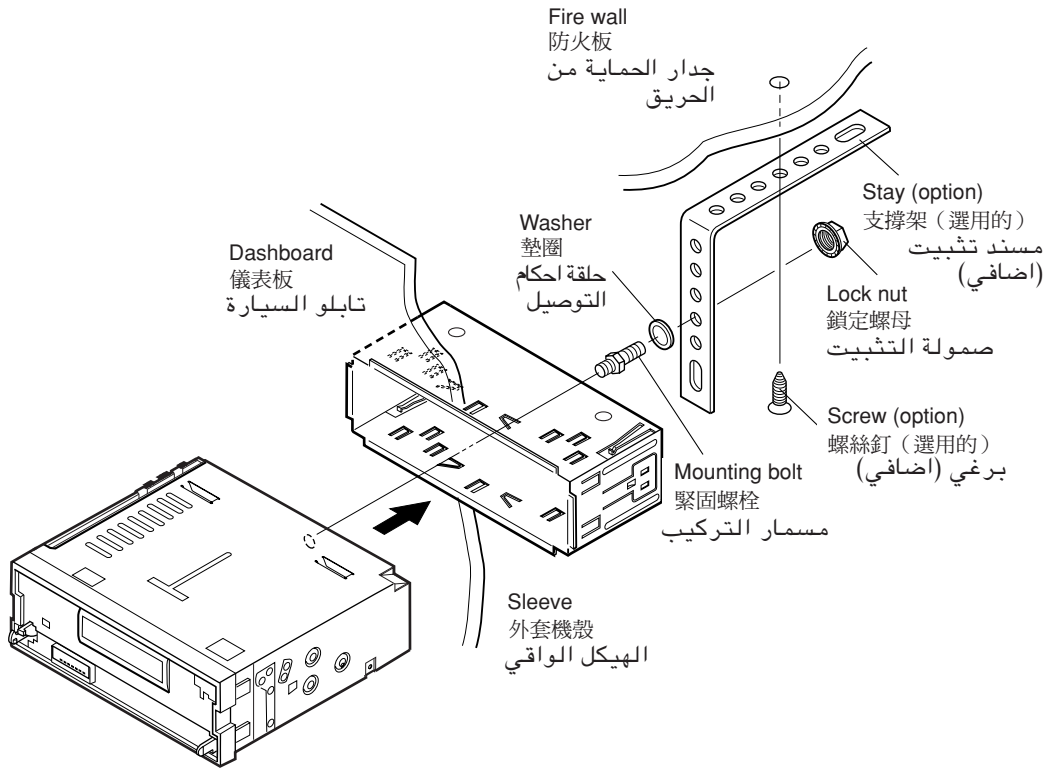

• When installing the unit without using the sleeve

• 若不使用外套機殼安裝本機

• عندما تركيب الجهاز بدون استخدام الهيكل الواقي

In a Toyota for example, first remove the car radio and install the unit in its place.

以豐田牌 (TOYOTA) 汽車為例：首先取出汽車收音機，然後將本機裝入其空出的位置。

على سبيل (TOYOTA) المثال، في سيارات نوع تويوتا، انزع راديو السيارة اولا بعد ذلك ركّب الجهاز في مكانه.

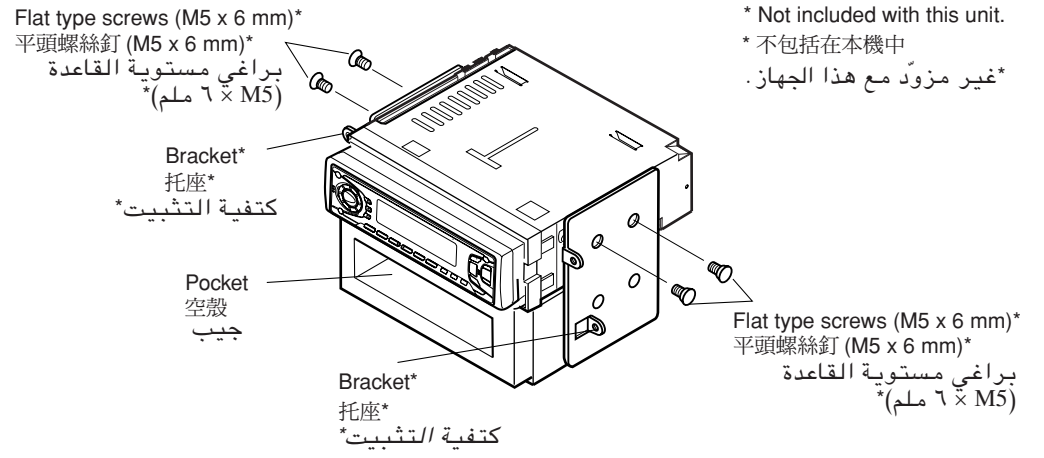

\* Not included with this unit.  
\* 不包括在本機中  
\* غير مزود مع هذا الجهاز.

**Note:** When installing the unit on the mounting bracket, make sure to use the 6 mm-long screws. If longer screws are used, they could damage the unit.

註：把本機安裝在托座上時，務必使用6mm長的螺絲釘。如使用過長的螺絲釘，會損壞本機。

**ملاحظة:** عند تركيب الجهاز على كتفية التثبيت، تأكد من استخدام براغي طول 6 ملم. في حالة استخدام براغي اطول من 6 ملم، فان ذلك يمكن ان يسبب تلف او ضرر الجهاز.

Removing the unit

• Before removing the unit, release the rear section.

1 Remove the control panel.

2 Remove the trim plate.

3 Insert the 2 handles into the slots, as shown. Then, while gently pulling the handles away from each other, slide out the unit. (Be sure to keep the handles after installing it.)

拆卸本機

• 在拆卸本機前，應將本機後部的固定和連接部分鬆開。

1 拆下控制板。

2 取下裝飾框。

3 按圖所示，將兩片板條型把手插入卡槽，然後輕穩地從兩側向外拉兩片把手，本機隨之拉出。(安裝本機後，務必保存好兩片把手)

نزع الجهاز من تابلو السيارة

• قبل نزع الجهاز، حرر الجزء الخلفي.

1 انزع لوحة التحكم.

2 انزع لوحة الزينة.

3 ادخل المساكين داخل الشقوق، كما هو مبين في الشكل. بعد ذلك، اثناء سحب المساكين بلطافة بعيدا الواحدة عن الاخرى، اسحب الجهاز الى الخارج. (تأكد من احتفاظك بالمساكين بعد تركيب الجهاز.)

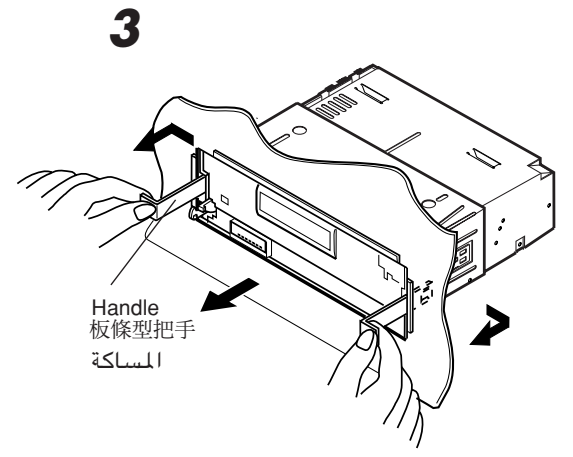
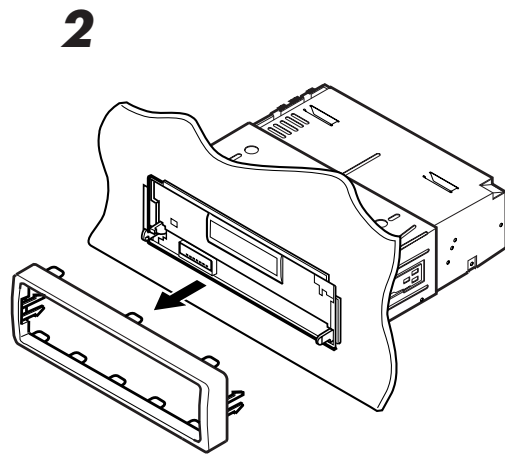
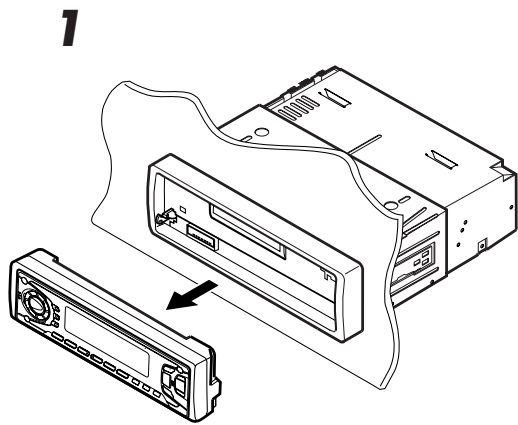

Parts list for installation and connection

The following parts are provided with this unit. After checking them, please set them correctly.

用於安裝和連接的零件裏

下列零件是隨本機提供的。清點以後，正確的將其裝配。

قائمة اجزاء التركيب والتوصيل

الاجزاء التالية مزودة مع الجهاز. بعد فحص هذه الاجزاء، يرجى تركيبهم بشكل صحيح.

Hard case/Control panel  
硬盒 / 控制面板  
صندوق صلب/ لوحة التحكم

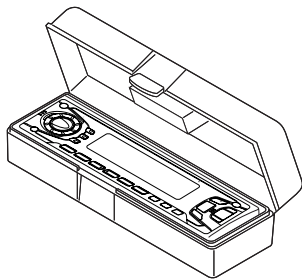

Sleeve  
外套機殼  
الهيكل الواقي

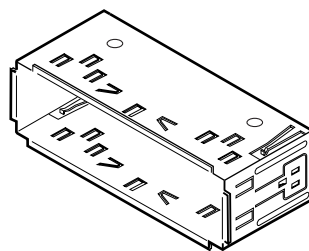

Trim plate  
裝飾框  
لوحة الزينة

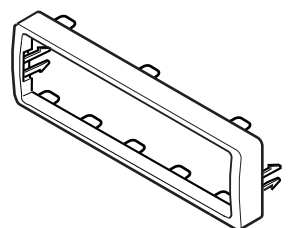

Power cord  
電路連接用的配線束  
سلك الطاقة الكهربائية

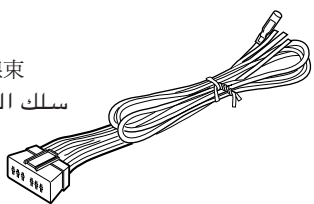

Washer (ø5)  
墊圈 (ø5)  
حلقة احكام  
التوصيل (قطر 5)



Lock nut (M5)  
鎖定螺母 (M5)  
صمولة التثبيت (M5)



Remote controller  
遙控控制器  
وحدة التحكم عن بعد

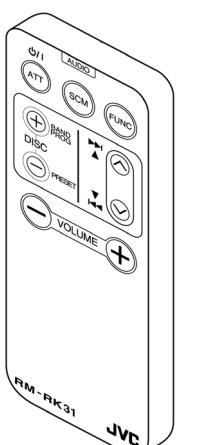

Handles  
板條型把手  
المساکين

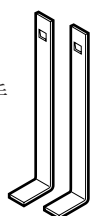

Mounting bolt (M5 x 20 mm)  
緊固螺栓 (M5 x 20 mm)  
مسمار التركيب (M5 x 20 mm)



Rubber cushion  
橡膠防震墊  
الحشوة المطاطية



Battery  
電池  
البطاريات  
CR2025





# ELECTRICAL CONNECTIONS

# 電路連接

# التوصيلات الكهربائية

To prevent short circuits, we recommend that you disconnect the battery's negative terminal and make all electrical connections before installing the unit. If you are not sure how to install this unit correctly, have it installed by a qualified technician.

為防止短路，建議在安裝本機之前，斷開電池的負極，並把所有電路都連接好。如果您不能確定如何正確地安裝本機，應請合格的技術人員來安裝。

لمنع حدوث تقصير في الدوائر الكهربائية، نوصي بفصل طرف البطارية السالب ثم عمل التوصيلات الكهربائية قبل تركيب الجهاز. في حالة عدم معرفتك بكيفية تركيب الجهاز بشكل صحيح، يرجى ترك عملية تركيب الجهاز لشخص مختص ومؤهل لتركيب مثل هذه الأجهزة.

**Note:**

This unit is designed to operate on **12 volts DC, NEGATIVE ground electrical systems**. If your vehicle does not have this system, a voltage inverter is required, which can be purchased at JVC car audio dealers.

- Replace the fuse with one of the specified rating. If the fuse blows frequently, consult your JVC car audio dealer.
- If noise is a problem... This unit incorporates a noise filter in the power circuit. However, with some vehicles, clicking or other unwanted noise may occur. If this happens, connect the unit's **rear ground terminal** (See connection diagram below.) to the car's chassis using shorter and thicker cords, such as copper braiding or gauge wire. If noise still persists, consult your JVC car audio dealer.
- Maximum input of the speakers should be more than 45 watts at the rear and 45 watts at the front, with an impedance of **4 to 8 ohms**.
- **Be sure to ground this unit to the car's chassis.**
- The heat sink becomes very hot after use. Be careful not to touch it when removing this unit.

**注意:**

- 本機僅可使用直流**12V**、**負極接地的電源系統**。如果您的車輛沒有這一電源系統，則需要一個電壓變換器，可以在 JVC 汽車音響分銷商處買到。
- 把保險絲更換為額定負荷值的保險絲。如果保險絲經常燒壞，請向 JVC 汽車音響分銷商詢問。
- 若出現噪音問題  
本機在電源回路帶有一個噪音濾波器。但是，在某些車輛上，會出現咯咯聲或其它噪音。如果發生這類情況，將本機後面的接地端子用短而粗的導線，如編織銅線或標準電纜，連接到汽車底盤上（見下面的電路接線圖）。如果噪音仍然持續存在，請向 JVC 汽車音響分銷商詢問。
- 後置揚聲器的最大輸入功率應大於 45 瓦，前置揚聲器的最大功率 45 瓦，其阻抗的為 **4-8 歐姆**。
- **務必將本機接到汽車底盤上。**
- 本機使用後，散熱片會很熱。因此，在移出本機時，小心不要觸摸散熱片。

**ملاحظة:**  
لقد صمم هذا الجهاز ليعمل بواسطة تيار كهربائي مباشر DC، ١٢ فولت، انظمة كهربائية تأريض سالب. في حالة عدم وجود مثل هذا النظام في سيارتك، يجب استخدام محول فولتاج، ويمكن شراء هذا المحول من وكلاء الاجهزة الصوتية للسيارات ماركة JVC.  
• استبدل الفيوز بآخر يحمل نفس القياسات الموصوفة. اذا تكرر احتراق الفيوز، يرجى استشارة وكلاء الاجهزة الصوتية للسيارات ماركة JVC.  
• اذا كان الضجيج هو المشكلة...

يستخدم هذا الجهاز فلتر ضجيج داخل دائرة الطاقة الكهربائية. مع ذلك، في بعض السيارات، يمكن ان يحدث نوع من الطقطقة أو الضجيج غير المرغوب. في حالة حدوث مثل ذلك، اوصل طرف التأريض الموجود في خلفية الجهاز (انظر رسم التوصيل في الاسفل) مع هيكل السيارة بواسطة استخدام اسلاك اقصر واسمك، مثل سلك النحاس المجذول أو سلك مقياسسي. في حالة عدم توقف الطقطقة أو الضجيج، يرجى استشارة وكلاء الاجهزة الصوتية للسيارات ماركة JVC.  
• يجب ان يكون الحد الاقصى لدخل السماعات اكثر من ٤٥ واط للسماعات الخلفية و ٤٥ واط للسماعات الامامية، مع ممانعة بين ٤ الى ٨ اوم.  
• تأكد من تأريض الجهاز مع هيكل السيارة.  
• تصبح صفيحة خفض الحرارة ساخنة جدا بعد الاستخدام. تأكد من عدم ملامستها عند نزع الجهاز.

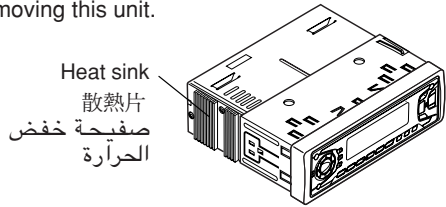

## Typical Connections / 典型的接線方法 / التوصيلات النموذجية

**Before connecting:** Check the wiring in the vehicle carefully. Incorrect connection may cause serious damage to this unit.

- 1 Connect the colored leads of the power cord to the car battery, speakers and automatic antenna (if any) in the following sequence.
  - ① Black: ground
  - ② Yellow: to car battery (constant 12V)
  - ③ Red: to an accessory terminal
  - ④ Blue: to automatic antenna (250mA max) (only for KS-FX901)
  - ⑤ Blue with white stripe: to other equipment (also used when the automatic power antenna requires power (200mA max))
  - ⑥ Orange with white stripe: to car light control switch (only for KS-FX901)
  - ⑦ Brown: to cellular phone system (For details, refer to the instructions of the cellular phone)
  - ⑧ Others: to speakers
- 2 Connect the antenna cord.
- 3 Finally connect the wiring harness to the unit.

**接線前:** 仔細檢查汽車內的線路。不正確的接線會導致本機嚴重損壞。

- 1 按下述順序將配線束各個不同色標的導線接頭分別接至電池、揚聲器和自動升降天線（如有裝設）：
  - ① 黑色：接地
  - ② 黃色：接至車裝電池（恆定 12V）
  - ③ 紅色：接至保險絲單元內的附屬端子
  - ④ 藍色帶有白色條紋：接至自動升降天線（最大 250 毫安）（只用於 KS-FX901）
  - ⑤ 藍色帶有白色條紋：接至其他音響設備（也用於當自動升降天線（最大 200 毫安））
  - ⑥ 橙色帶有白色條紋：接至汽車燈光控制開關（只用於 KS-FX901）
  - ⑦ 棕色：接至蜂窩式移動電話系統（預知詳情，請參閱蜂窩式移動電話系統的操作指示）
  - ⑧ 其他：接至揚聲器
- 2 將天線的電線連接起來。
- 3 最後，把配線束的插頭插在本機上。

**قبل البدء بالتوصيل:** تأكد من شبكة الاسلاك في السيارة بدقة. يمكن ان يسبب التوصيل الخاطيء الى حصول عطل حقيقي للجهاز.

- 1 اوصل الاسلاك الملونة لسلك تزويد الطاقة الكهربائية مع بطارية السيارة، السماعات والهوائي الاوتوماتيكي (ان وجد) حسب التسلسل التالي.
  - ① السلك الاسود: مع الارض (مع هيكل السيارة)
  - ② السلك الاصفر: مع بطارية السيارة (ثابت ١٢ فولت)
  - ③ السلك الاحمر: مع الطرف الاضافي
  - ④ السلك الازرق: مع الهوائي الاوتوماتيكي (الحد الاقصى ٢٥٠ ميلي امبير) (فقط للموديل KS-FX901)
  - ⑤ السلك الازرق بالخطوط الابيض: مع الاجهزة الاخرى: يستعمل ايضا عندما يتطلب الهوائي الاوتوماتيكي طاقة اكثر من ٢٠٠ ميلي امبير.
  - ⑥ السلك البرتقالي المخطط بالابيض: مع مفتاح ضبط ضوء السيارة (فقط للموديل KS-FX901)
  - ⑦ السلك البني: مع جهاز التلفون الخليوي (للتفاصيل، ارجع الى تعليمات التلفون الخليوي)
  - ⑧ الاسلاك الاخرى: مع السماعات
- 2 اوصل سلك الهوائي.
- 3 اخيرا، اوصل حامل الاسلاك مع الجهاز.

\* Before connecting the CD changer, make sure that the unit is turned off.  
\* 連接 CD 轉換器之前，應先將本機關閉。

\* قبل توصيل مبدل الاسطوانة المدمجة CD، تأكد من ايقاف تشغيل الجهاز.

JVC CD changer or another external component  
JVC CD 轉換器或其他外接部件  
مبدل اسطوانة مدمجة CD ماركة JVC او جهاز كمبونانت خارجي اخر

We recommend that you connect one of the CH-X series CD changers.  
• If your CD changer is one of the KD-MK series, you need an optional cord (KS-U15K). You can also use an external component such as a portable MD player by connecting the Line Input Adaptor KS-U57 (not supplied). (See diagram B.)  
我們建議您應當接上一個 CH-X 系列的 CD 轉換器。  
• 如果您的 CD 轉換器是 KD-MK 系列，您需要選用一條連接線 KS-U15K。您可以通過聯結線輸入適配器 KS-U57（未提供）來使用外接部件，如手提式 MD 播放機等（見 B 圖示）

نوصي بتوصيل احد مبدلات الاسطوانات المدمجة CD من سلسلة CH-X.  
• اذا كان مبدل الاسطوانات المدمجة CD الذي تمتلكه من سلسلة KD-MK، سوف تحتاج الى سلك اضافي (KS-U15K).  
يمكنك ايضا استعمال جهاز كمبونانت خارجي مثل مبدل اسطوانة MD الميني ديسك وذلك بتوصيل مهابىء دخل الخط KS-U57 (غير مزود مع هذا الجهاز) (انظر الرسم التخطيطي B)

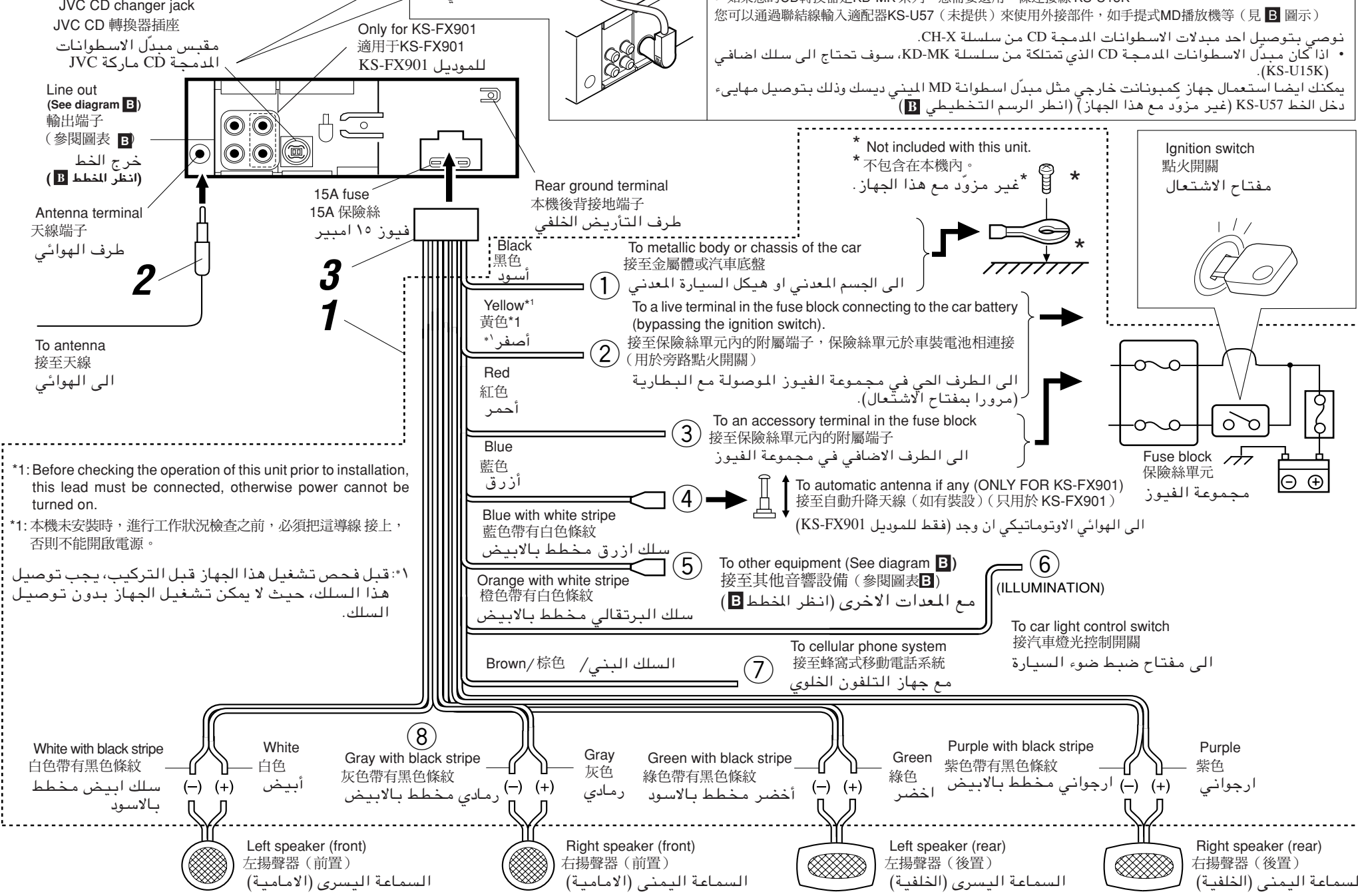

\*1: Before checking the operation of this unit prior to installation, this lead must be connected, otherwise power cannot be turned on.  
\*1: 本機未安裝時，進行工作狀況檢查之前，必須把這導線接上，否則不能開啟電源。

\* قبل فحص تشغيل هذا الجهاز قبل التركيب، يجب توصيل هذا السلك، حيث لا يمكن تشغيل الجهاز بدون توصيل السلك.

\* Not included with this unit.  
\* 不包含在本機內。  
\* غير مزود مع هذا الجهاز.

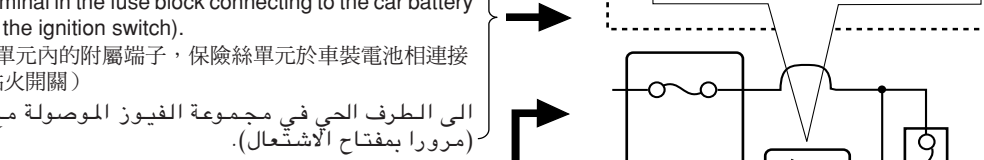
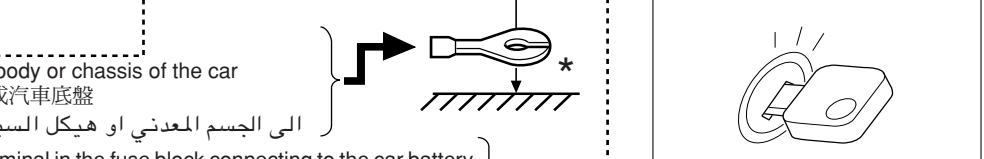

## PRECAUTIONS on power supply and speaker connections:

- DO NOT connect the speaker leads of the power cord to the car battery; otherwise, the unit will be seriously damaged.
- Connect the black lead (ground), yellow lead (to car battery, constant 12V), and red lead (to an accessory terminal) correctly.
- BEFORE connecting the speaker leads of the power cord to the speakers, check the speaker wiring in your car.
  - If the speaker wiring in your car is as illustrated in Fig. 1 and Fig. 2 below, DO NOT connect the unit using that original speaker wiring. If you do, the unit will be seriously damaged. Redo the speaker wiring so that you can connect the unit to the speakers as illustrated in Fig. 3.
  - If the speaker wiring in your car is as illustrated in Fig. 3, you can connect the unit using the original speaker wiring in your car.
  - If you are not sure of the speaker wiring of your car, consult your car dealer.

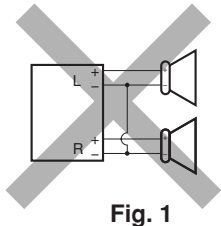

Fig. 1

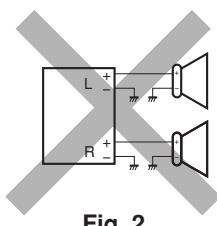

Fig. 2

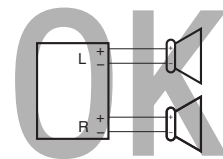

Fig. 3

## 電源和揚聲器接線注意事項：

- 切勿把揚聲器導線接頭接至電池，否則本機將會嚴重損壞。
- 正確地連接黑色導線接頭（接地）、黃色導線接頭（接車裝電池，恆定 12V）和紅色導線接頭（接至保險絲單元的附屬端子）。
- 在把揚聲器導線接頭接至揚聲器之前，檢查您汽車上的揚聲器線路：
  - 如果您汽車上揚聲器線路象圖 1 和圖 2 所示，不要使用原裝的揚聲器線路。如果使用，本機將嚴重損壞。要重新連接揚聲器線路，可按圖 3 所示，把本機與揚聲器相連接。
  - 如果您汽車上揚聲器線路象圖 3 所示，可使用原裝的揚聲器線路與本機相連接。
  - 如果您不能確定您汽車上揚聲器線路，請向您的汽車分銷商詢問。

## تنبيهات حول تزويد الطاقة الكهربائية وتوصيل السماعات:

- لا توصّل اسلاك تزويد طاقة السماعات مع بطارية السيارة، لأن ذلك يؤدي الى حصول ضرر للسماعات.
- اوصل السلك الاسود (الارضى)، والسلك الاصفر (مع بطارية السيارة، ثابت ١٢ فولت)، والسلك الاحمر (مع الطرف الاضافي) بشكل صحيح.
- قبل توصيل اسلاك تزويد طاقة السماعات مع السماعات، افحص شبكة اسلاك السماعات داخل سيارتك.
- اذا كانت شبكة اسلاك السماعات داخل سيارتك كما هي مبينة في الشكل ١ والشكل ٢ الموجودة في الاسفل، لا توصّل الجهاز بواسطة استخدام شبكة اسلاك السماعات الاصلية. اذا تم توصيل الجهاز بهذه الطريقة، سيؤدي ذلك الى حصول ضرر. اعد عمل شبكة اسلاك السماعات بحيث يمكنك توصيل الجهاز مع السماعات كما هو مبين في الشكل ٣.
- اذا كانت شبكة اسلاك السماعات داخل سيارتك كما هي مبينة في الشكل ٣، يمكنك توصيل الجهاز بواسطة استخدام شبكة اسلاك السماعات الاصلية داخل سيارتك.
- في حالة عدم معرفتك بشبكة اسلاك السماعات داخل سيارتك، استشر الوكيل او ذوي الخبرة بهذا الخصوص.

## Connecting the leads / 導線接頭的連接 / توصيل الاسلاك

Twist the core wires when connecting.  
連接時剝掉導線的外皮。

ايرم الاسلاك بشكل صحيح قبل التوصيل.

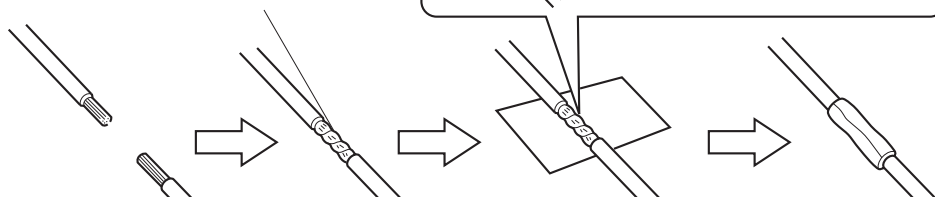

Solder the core wires to connect them securely.  
將線芯牢固地焊接在一起。  
الحم الاسلاك بشكل صحيح ومحمك بعد التوصيل.

### CAUTION / 注意 / تنبيه

- To prevent short-circuit, cover the terminals of the UNUSED leads with insulating tape.

- 為防止電源短路，請用絕緣帶包住未使用電線的端子。

- من اجل منع التقصير في الدوائر - الكهربائية، ضع شريط عازل ولاصق على اطراف الاسلاك غير المستعملة.

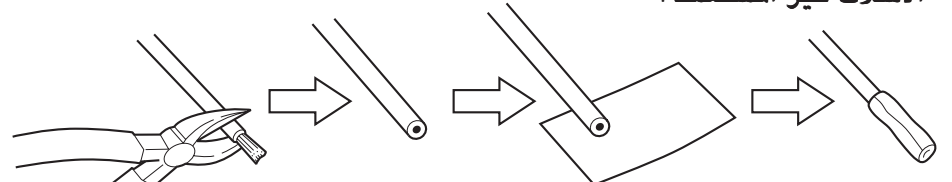

## B Connections Adding Other Equipment / 連接附加的其他音響設備 / توصيل الاجهزة الاخرى الاضافية

You can connect an amplifier and other equipment to upgrade your car stereo system.

- Connect the remote lead (blue with white stripe) to the remote lead of the other equipment so that power can be supplied through this unit.
- For amplifier only:
  - Connect this unit's line-out terminals to the amplifier's line-in terminals.
  - Disconnect the speakers from this unit, connect them to the amplifier. Leave the speaker leads of this unit unused. (Cover the terminals of these unused leads with insulating tape, as illustrated above.)

本機帶有多套輸出端子，可用一個功率放大器和其他音響設備來提升您汽車內的立體聲音響系統。

- 把遠端的線接頭（藍色帶有白色條紋）和遠端的其他音響設備的接頭連接，則可通過本機供電。
- 僅附加功率放大器：
  - 用導線把本機的輸出端子和功率放大器的輸入端子連接起來。
  - 將揚聲器和本機斷開，再和放大器連上。將本機的揚聲器線路放置不用。（如圖所示，用絕緣膠將這些不用的線頭包起來。）

يمكنك توصيل مضخم صوت وجهاز اخر لتحسين اداء جهاز ستيريو السيارة.

- اوصل سلك التحكم عن بعد (الازرق المخطط بالابيض) مع سلك التحكم عن بعد للجهاز الاخر لكي يتم تزويد الطاقة من خلال هذا الجهاز.
- فقط لمضخم الصوت:
  - اوصل اطراف خرج - الخط لهذا الجهاز مع اطراف دخل - الخط لمضخم الصوت.
  - افصل السماعات من هذا الجهاز، اوصلهم مع مضخم الصوت. اترك اسلاك سماعات هذا الجهاز بدون استعمال. (غطي اطراف هذه الاسلاك غير المستعملة بشريط عازل، كما هو موضح في الاعلى).

## Amplifier / 功率放大器 / مضخم الصوت

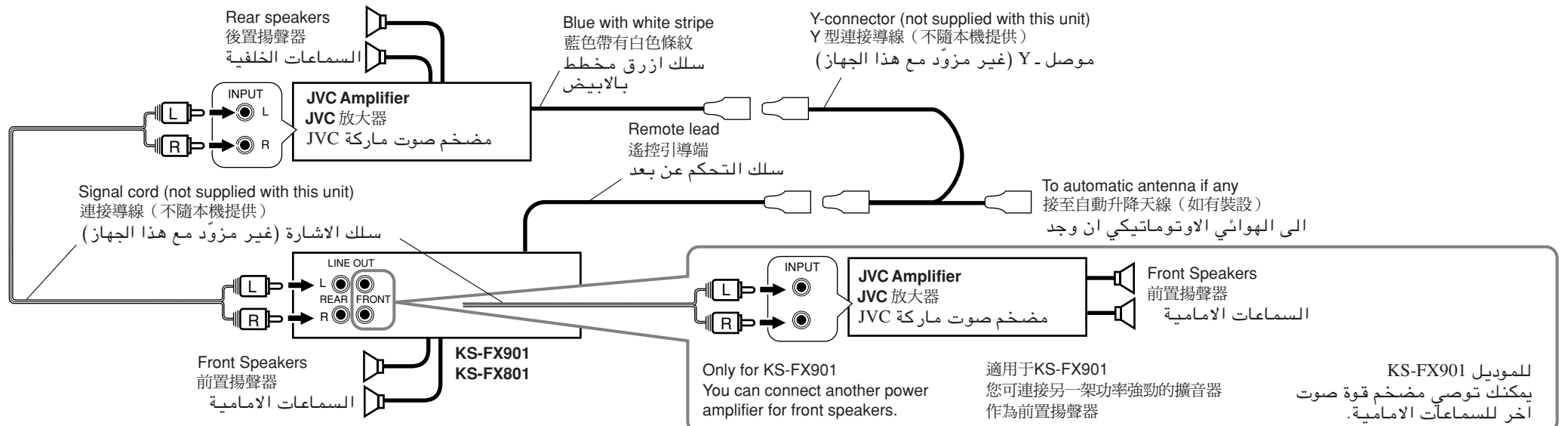

## External Component / 外接部件 / جهاز الكمبيوتر الخارجي

Line Input Adaptor KS-U57 (not supplied with this unit)

線輸入適配器 KS-U57 (不隨本機提供)

مهائىء دخل الخط KS-U57 (غير مزود مع هذا الجهاز)

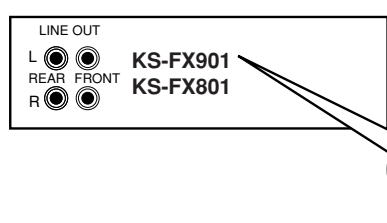

Signalcord (not supplied with this unit)

連接導線 (不隨本機提供)

سلك الاشارة (غير مزود مع هذا الجهاز)

External component

外接部件

جهاز الكمبيوتر الخارجي

CD changer jack  
CD 轉換器插座  
مقبس مبدل الاسطوانة المدمجة CD